

Article number: 0107072

Description: Retaining ring AK 55 DIN 983

## Measures

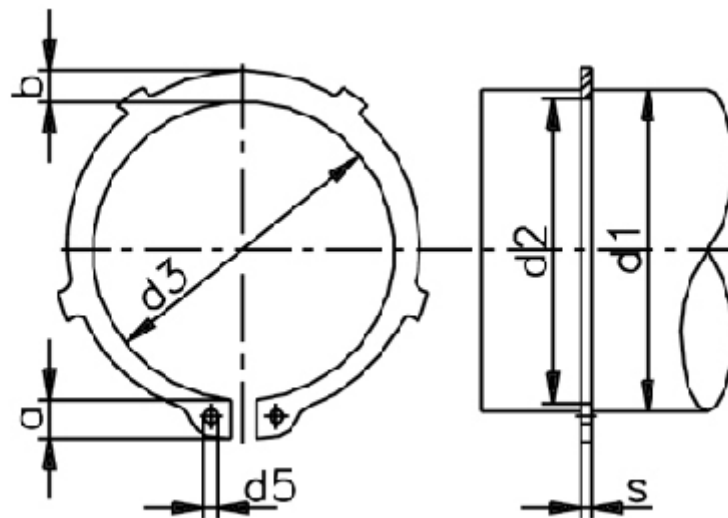

a max	= 8.2	FN kN	= 42.00	Number of serrations	= 6
AN mm <sup>2</sup>	= 252.0	FRg kN	= 11.4	s	= 2.00
b	= 5.4	FR kN	= 71.4	t	= 1.50
d1	= 55	g	= 2.5	tol	= -0.30
d2	= 52.0	K kN-mm	= 130.0	tol	= -0.07
d3	= 50.8	m min	= 2.15	tol	= +0,46-1,10
d5 min	= 2.5	n abl x 1000	= 8	Tong	= ZGA-3
Description	= AK 55	Nominal drive	= 4.5	Weight kg/1000	= 12.99